

2M-BIT CMOS STATIC RAM  
128K-WORD BY 16-BIT  
EXTENDED TEMPERATURE OPERATION**Description**

The  $\mu$ PD442012A-X is a high speed, low power, 2,097,152 bits (131,072 words by 16 bits) CMOS static RAM.

The  $\mu$ PD442012A-X has two chip enable pins (/CE1, CE2) to extend the capacity.

The  $\mu$ PD442012A-X is packed in 48-pin PLASTIC TSOP (I) (Normal bent).

**Features**

- 131,072 words by 16 bits organization
- ★ • Fast access time : 50, 55, 70, 85, 100, 120 ns (MAX.)
- Byte data control : /LB (I/O1 - I/O8), /UB (I/O9 - I/O16)
- Low voltage operation  
(BB version :  $V_{CC} = 2.7$  to  $3.6$  V, BC version :  $V_{CC} = 2.2$  to  $3.6$  V, DD version :  $V_{CC} = 1.8$  to  $2.2$  V)
- Low  $V_{CC}$  data retention : 1.0 V (MIN.)
- Operating ambient temperature :  $T_A = -25$  to  $+85$  °C
- Output Enable input for easy application
- Two Chip Enable inputs : /CE1, CE2

Part number	Access time ns (MAX.)	Operating supply voltage V	Operating ambient temperature °C	Supply current		
				At operating mA (MAX.)	At standby $\mu$ A (MAX.)	At data retention $\mu$ A (MAX.)
★ $\mu$ PD442012A-BBxxX	50 <sup>Note 1</sup> , 55, 70, 85	2.7 to 3.6	-25 to +85	30 <sup>Note 2</sup> 35 <sup>Note 3</sup> 40 <sup>Note 4</sup>	4	2
$\mu$ PD442012A-BCxxX	70, 85, 100	2.2 to 3.6		30		
★ $\mu$ PD442012A-DDxxX	85, 100, 120	1.8 to 2.2		15	3	

- ★ **Notes** 1.  $V_{CC} \geq 3.0$  V
- ★ 2. Cycle time  $\geq 70$  ns
- ★ 3. Cycle time = 55 ns
- ★ 4. Cycle time = 50 ns

The information in this document is subject to change without notice. Before using this document, please confirm that this is the latest version.  
Not all devices/types available in every country. Please check with local NEC representative for availability and additional information.

Ordering Information

Part number	Package	Access time ns (MAX.)	Operating supply voltage V	Operating temperature °C	Remark
★ μPD442012AGY-BB55X-MJH	48-pin PLASTIC TSOP (I) (12×18) (Normal bent)	55, 50 <sup>Note</sup>	2.7 to 3.6	-25 to +85	BB version
μPD442012AGY-BB70X-MJH		70			
μPD442012AGY-BB85X-MJH		85			
μPD442012AGY-BC70X-MJH		70	2.2 to 3.6		BC version
μPD442012AGY-BC85X-MJH		85			
μPD442012AGY-BC10X-MJH		100			
μPD442012AGY-DD85X-MJH		85	1.8 to 2.2		DD version
μPD442012AGY-DD10X-MJH		100			
μPD442012AGY-DD12X-MJH		120			

★ **Note** V<sub>cc</sub> ≥ 3.0 V

Pin Configuration (Marking Side)

/xxx indicates active low signal.

48-pin PLASTIC TSOP (I) (12×18) (Normal bent)

[ μPD442012AGY-BBxxX-MJH ]

[ μPD442012AGY-BCxxX-MJH ]

[ μPD442012AGY-DDxxX-MJH ]

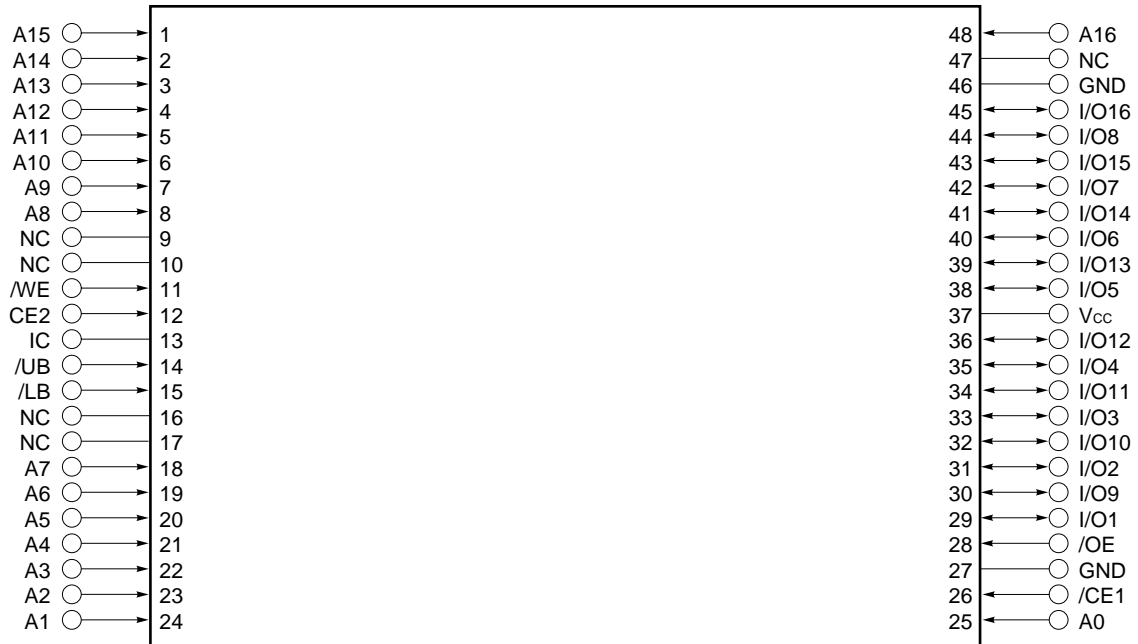

- A0 - A16 : Address inputs
- I/O1 - I/O16 : Data inputs / outputs
- /CE1, CE2 : Chip Enable 1, 2
- /WE : Write Enable
- /OE : Output Enable
- /LB, /UB : Byte data select
- Vcc : Power supply
- GND : Ground
- NC : No Connection
- IC <sup>Note</sup> : Internal Connection

**Note** Leave this pin unconnected or connect to GND.

**Remark** Refer to **Package Drawing** for the 1-pin index mark.

Block Diagram

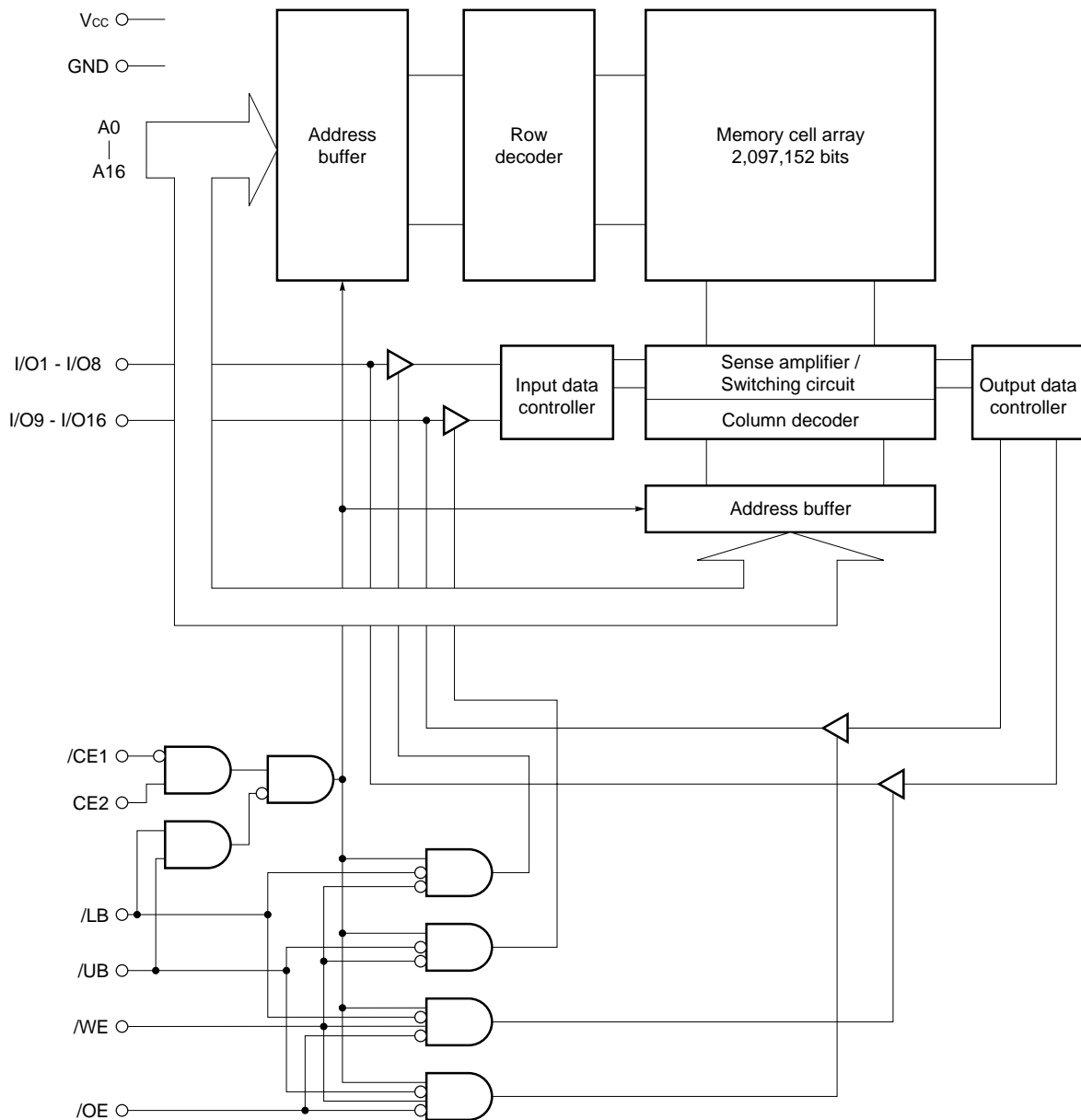

Truth Table

/CE1	CE2	/OE	/WE	/LB	/UB	Mode	I/O		Supply current
							I/O1 - I/O8	I/O9 - I/O16	
H	×	×	×	×	×	Not selected	High impedance	High impedance	I <sub>SB</sub>
×	L	×	×	×	×	Not selected	High impedance	High impedance	
×	×	×	×	H	H	Not selected	High impedance	High impedance	
L	H	H	H	L	×	Output disable	High impedance	High impedance	I <sub>CCA</sub>
				×	L	Output disable	High impedance	High impedance	
		L	H	L	L	Word read	D <sub>OUT</sub>	D <sub>OUT</sub>	
				L	H	Lower byte read	D <sub>OUT</sub>	High impedance	
				H	L	Upper byte read	High impedance	D <sub>OUT</sub>	
		×	L	L	L	Word write	D <sub>IN</sub>	D <sub>IN</sub>	
				L	H	Lower byte write	D <sub>IN</sub>	High impedance	
H	L			Upper byte write	High impedance	D <sub>IN</sub>			

Remark × : V<sub>IH</sub> or V<sub>IL</sub>

**Electrical Specifications**

**Absolute Maximum Ratings**

Parameter	Symbol	Product	Rating	Unit
Supply voltage	V <sub>CC</sub>	μPD442012A-BBxxX, μPD442012A-BCxxX	-0.5 <sup>Note</sup> to +4.0	V
		μPD442012A-DDxxX	-0.5 <sup>Note</sup> to +2.7	
Input / Output voltage	V <sub>T</sub>	μPD442012A-BBxxX, μPD442012A-BCxxX	-0.5 <sup>Note</sup> to V <sub>CC</sub> +0.4 (4.0 V MAX.)	V
		μPD442012A-DDxxX	-0.5 <sup>Note</sup> to V <sub>CC</sub> +0.4 (2.7 V MAX.)	
Operating ambient temperature	T <sub>A</sub>		-25 to +85	°C
Storage temperature	T <sub>stg</sub>		-55 to +125	°C

**Note** -3.0 V (MIN.) (Pulse width : 30 ns)

**Caution** Exposing the device to stress above those listed in Absolute Maximum Rating could cause permanent damage. The device is not meant to be operated under conditions outside the limits described in the operational section of this specification. Exposure to Absolute Maximum Rating conditions for extended periods may affect device reliability.

**Recommended Operating Conditions**

Parameter	Symbol	Condition	μPD442012A-BBxxX		μPD442012A-BCxxX		μPD442012A-DDxxX		Unit
			MIN.	MAX.	MIN.	MAX.	MIN.	MAX.	
Supply voltage	V <sub>CC</sub>		2.7	3.6	2.2	3.6	1.8	2.2	V
High level input voltage	V <sub>IH</sub>	2.7 V ≤ V <sub>CC</sub> ≤ 3.6 V	2.4	V <sub>CC</sub> +0.4	2.4	V <sub>CC</sub> +0.4	-	-	V
		2.2 V ≤ V <sub>CC</sub> < 2.7 V	-	-	2.0	V <sub>CC</sub> +0.3	-	-	
		1.8 V ≤ V <sub>CC</sub> < 2.2 V	-	-	-	-	1.6	V <sub>CC</sub> +0.2	
Low level input voltage	V <sub>IL</sub>		-0.3 <sup>Note</sup>	+0.5	-0.3 <sup>Note</sup>	+0.4	-0.2 <sup>Note</sup>	+0.2	V
Operating ambient temperature	T <sub>A</sub>		-25	+85	-25	+85	-25	+85	°C

**Note** -1.0 V (MIN.) (Pulse width : 20 ns)

**Capacitance (T<sub>A</sub> = 25 °C, f = 1 MHz)**

Parameter	Symbol	Test condition	MIN.	TYP.	MAX.	Unit
Input capacitance	C <sub>IN</sub>	V <sub>IN</sub> = 0 V			8	pF
Input / Output capacitance	C <sub>I/O</sub>	V <sub>I/O</sub> = 0 V			10	pF

- Remarks**
1. V<sub>IN</sub> : Input voltage  
V<sub>I/O</sub> : Input / Output voltage
  2. These parameters are not 100% tested.

DC Characteristics (Recommended Operating Conditions Unless Otherwise Noted) (1/2)

Parameter	Symbol	Test condition	μPD442012A-BBxxX			Unit
			MIN.	TYP.	MAX.	
Input leakage current	I <sub>LI</sub>	V <sub>IN</sub> = 0 V to V <sub>CC</sub>	-1.0		+1.0	μA
I/O leakage current	I <sub>LO</sub>	V <sub>I/O</sub> = 0 V to V <sub>CC</sub> , /CE1 = V <sub>IH</sub> or CE2 = V <sub>IL</sub> or /WE = V <sub>IL</sub> or /OE = V <sub>IH</sub>	-1.0		+1.0	μA
★ Operating supply current	I <sub>CCA1</sub>	/CE1 = V <sub>IL</sub> , CE2 = V <sub>IH</sub> , I <sub>I/O</sub> = 0 mA, Minimum cycle time	Cycle time = 50 ns	-	40	mA
			Cycle time = 55 ns	-	35	
			Cycle time ≥ 70 ns	-	30	
★	I <sub>CCA2</sub>	/CE1 = V <sub>IL</sub> , CE2 = V <sub>IH</sub> , I <sub>I/O</sub> = 0 mA, Cycle time = ∞		-	4	
★	I <sub>CCA3</sub>	/CE1 ≤ 0.2 V, CE2 ≥ V <sub>CC</sub> - 0.2 V, Cycle time = 1 μs, I <sub>I/O</sub> = 0 mA, V <sub>IL</sub> ≤ 0.2 V, V <sub>IH</sub> ≥ V <sub>CC</sub> - 0.2 V		-	4	
Standby supply current	I <sub>SB</sub>	/CE1 = V <sub>IH</sub> or CE2 = V <sub>IL</sub> or /LB = /UB = V <sub>IH</sub>		-	0.6	mA
	I <sub>SB1</sub>	/CE1 ≥ V <sub>CC</sub> - 0.2 V, CE2 ≥ V <sub>CC</sub> - 0.2 V		0.3	4	
	I <sub>SB2</sub>	CE2 ≤ 0.2 V		0.3	4	
	I <sub>SB3</sub>	/LB = /UB ≥ V <sub>CC</sub> - 0.2 V, /CE1 ≤ 0.2 V, CE2 ≥ V <sub>CC</sub> - 0.2 V		0.3	4	
High level output voltage	V <sub>OH</sub>	I <sub>OH</sub> = -0.5 mA	2.4			V
Low level output voltage	V <sub>OL</sub>	I <sub>OL</sub> = 1.0 mA			0.4	V

Remarks 1. V<sub>IN</sub> : Input voltage

V<sub>I/O</sub> : Input / Output voltage

2. These DC characteristics are in common regardless of product specification.

DC Characteristics (Recommended Operating Conditions Unless Otherwise Noted) (2/2)

Parameter	Symbol	Test condition	μPD442012A-BCxxX			μPD442012A-DDxxX			Unit		
			MIN.	TYP.	MAX.	MIN.	TYP.	MAX.			
Input leakage current	I <sub>LI</sub>	V <sub>IN</sub> = 0 V to V <sub>CC</sub>	-1.0		+1.0	-1.0		+1.0	μA		
I/O leakage current	I <sub>LO</sub>	V <sub>I/O</sub> = 0 V to V <sub>CC</sub> , /CE1 = V <sub>IH</sub> or CE2 = V <sub>IL</sub> or /WE = V <sub>IL</sub> or /OE = V <sub>IH</sub>	-1.0		+1.0	-1.0		+1.0	μA		
Operating supply current	I <sub>CCA1</sub>	/CE1 = V <sub>IL</sub> , CE2 = V <sub>IH</sub> ,		-	30		-	-	mA		
		I <sub>I/O</sub> = 0 mA, V <sub>CC</sub> ≤ 2.7 V		-	25		-	-			
		Minimum cycle time V <sub>CC</sub> ≤ 2.2 V		-	-		-	15			
	I <sub>CCA2</sub>	/CE1 = V <sub>IL</sub> , CE2 = V <sub>IH</sub> ,		-	4		-	-			
		I <sub>I/O</sub> = 0 mA, V <sub>CC</sub> ≤ 2.7 V		-	2		-	-			
		Cycle time = ∞ V <sub>CC</sub> ≤ 2.2 V		-	-		-	1			
	I <sub>CCA3</sub>	/CE1 ≤ 0.2 V, CE2 ≥ V <sub>CC</sub> - 0.2 V, Cycle time = 1 μs, I <sub>I/O</sub> = 0 mA,		-	4		-	-			
		V <sub>IL</sub> ≤ 0.2 V, V <sub>CC</sub> ≤ 2.7 V		-	3		-	-			
		V <sub>IH</sub> ≥ V <sub>CC</sub> - 0.2 V V <sub>CC</sub> ≤ 2.2 V		-	-		-	3			
	Standby supply current	I <sub>SB</sub>	/CE1 = V <sub>IH</sub> or CE2 = V <sub>IL</sub> or /LB = /UB = V <sub>IH</sub>		-	0.6		-		-	mA
			V <sub>CC</sub> ≤ 2.7 V		-	0.6		-		-	
			V <sub>CC</sub> ≤ 2.2 V		-	-		-		0.6	
I <sub>SB1</sub>		/CE1 ≥ V <sub>CC</sub> - 0.2 V, CE2 ≥ V <sub>CC</sub> - 0.2 V		0.3	4		-	-	μA		
		V <sub>CC</sub> ≤ 2.7 V		0.25	3.5		-	-			
		V <sub>CC</sub> ≤ 2.2 V		-	-		0.2	3			
I <sub>SB2</sub>		CE2 ≤ 0.2 V		0.3	4		-	-			
		V <sub>CC</sub> ≤ 2.7 V		0.25	3.5		-	-			
		V <sub>CC</sub> ≤ 2.2 V		-	-		0.2	3			
I <sub>SB3</sub>		/LB = /UB ≥ V <sub>CC</sub> - 0.2 V, /CE1 ≤ 0.2 V, CE2 ≥ V <sub>CC</sub> - 0.2 V		0.3	4		-	-			
		V <sub>CC</sub> ≤ 2.7 V		0.25	3.5		-	-			
		V <sub>CC</sub> ≤ 2.2 V		-	-		0.2	3			
High level output voltage	V <sub>OH</sub>	I <sub>OH</sub> = -0.5 mA	2.4			-				V	
		V <sub>CC</sub> ≤ 2.7 V	1.8			-					
		V <sub>CC</sub> ≤ 2.2 V	-			1.5					
Low level output voltage	V <sub>OL</sub>	I <sub>OL</sub> = 1.0 mA			0.4			-	V		
		V <sub>CC</sub> ≤ 2.7 V			0.4			-			
		V <sub>CC</sub> ≤ 2.2 V			-			0.4			

★ ★ ★ ★ ★ ★ ★ ★ ★ ★  
**Remarks 1.** V<sub>IN</sub> : Input voltage

V<sub>I/O</sub> : Input / Output voltage

**2.** These DC characteristics are in common regardless of product specification.



AC Characteristics (Recommended Operating Conditions Unless Otherwise Noted)

AC Test Conditions

[ μPD442012A-BB55X, μPD442012A-BB70X, μPD442012A-BB85X ]

Input Waveform (Rise and Fall Time ≤ 5 ns)

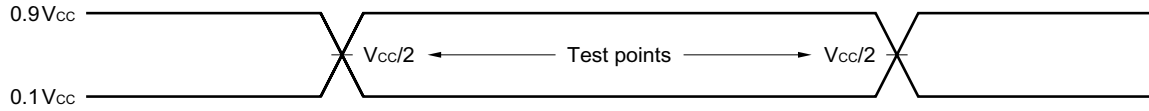

Output Waveform

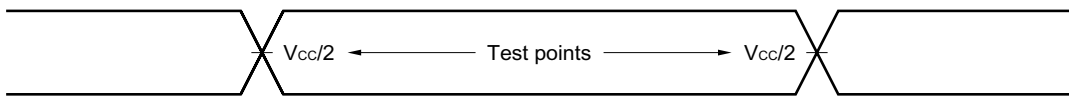

Output Load

1TTL + 50 pF

[ μPD442012A-BC70X, μPD442012A-BC85X, μPD442012A-BC10X ]

Input Waveform (Rise and Fall Time ≤ 5 ns)

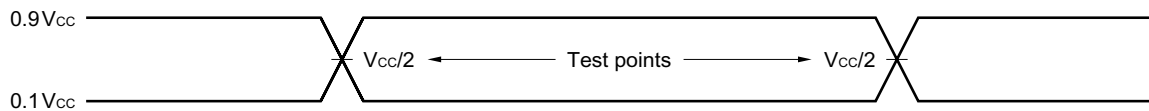

Output Waveform

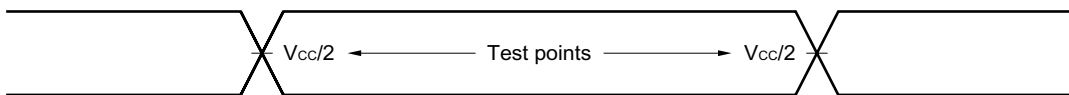

Output Load

1TTL + 30 pF

[ μPD442012A-DD85X, μPD442012A-DD10X, μPD442012A-DD12X ]

Input Waveform (Rise and Fall Time ≤ 5 ns)

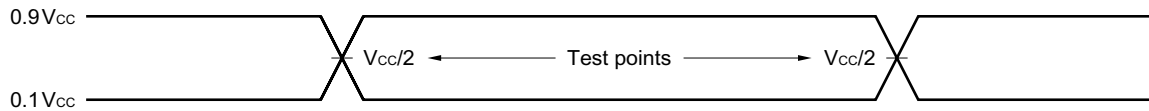

Output Waveform

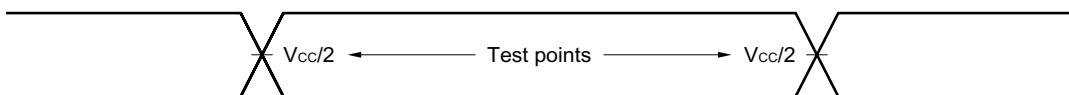

Output Load

1TTL + 30 pF

★ Read Cycle (1/3) (BB version)

Parameter	Symbol	μPD442012A-BB55X				μPD442012A		μPD442012A		Unit	Condition
		V <sub>CC</sub> ≥ 3.0 V				-BB70X		-BB85X			
		MIN.	MAX.	MIN.	MAX.	MIN.	MAX.	MIN.	MAX.		
Read cycle time	t <sub>RC</sub>	50		55		70		85		ns	
Address access time	t <sub>AA</sub>		50		55		70		85	ns	Note 1
/CE1 access time	t <sub>CO1</sub>		50		55		70		85	ns	
CE2 access time	t <sub>CO2</sub>		50		55		70		85	ns	
/OE to output valid	t <sub>OE</sub>		30		30		35		40	ns	
/LB, /UB to output valid	t <sub>BA</sub>		50		55		70		85	ns	
Output hold from address change	t <sub>OH</sub>	10		10		10		10		ns	
/CE1 to output in low impedance	t <sub>LZ1</sub>	10		10		10		10		ns	Note 2
CE2 to output in low impedance	t <sub>LZ2</sub>	10		10		10		10		ns	
/OE to output in low impedance	t <sub>OLZ</sub>	5		5		5		5		ns	
/LB, /UB to output in low impedance	t <sub>BLZ</sub>	10		10		10		10		ns	
/CE1 to output in high impedance	t <sub>HZ1</sub>		20		20		25		30	ns	
CE2 to output in high impedance	t <sub>HZ2</sub>		20		20		25		30	ns	
/OE to output in high impedance	t <sub>OHZ</sub>		20		20		25		30	ns	
/LB, /UB to output in high impedance	t <sub>BHZ</sub>		20		20		25		30	ns	

- Notes 1. The output load is 1TTL + 50 pF.  
 2. The output load is 1TTL + 5 pF.

Read Cycle (2/3) (BC version)

Parameter	Symbol	μPD442012A		μPD442012A		μPD442012A		Unit	Condition
		-BC70X		-BC85X		-BC10X			
		MIN.	MAX.	MIN.	MAX.	MIN.	MAX.		
Read cycle time	t <sub>RC</sub>	70		85		100		ns	
Address access time	t <sub>AA</sub>		70		85		100	ns	Note 1
/CE1 access time	t <sub>CO1</sub>		70		85		100	ns	
CE2 access time	t <sub>CO2</sub>		70		85		100	ns	
/OE to output valid	t <sub>OE</sub>		35		40		50	ns	
/LB, /UB to output valid	t <sub>BA</sub>		70		85		100	ns	
Output hold from address change	t <sub>OH</sub>	10		10		10		ns	
/CE1 to output in low impedance	t <sub>LZ1</sub>	10		10		10		ns	Note 2
CE2 to output in low impedance	t <sub>LZ2</sub>	10		10		10		ns	
/OE to output in low impedance	t <sub>OLZ</sub>	5		5		5		ns	
/LB, /UB to output in low impedance	t <sub>BLZ</sub>	10		10		10		ns	
/CE1 to output in high impedance	t <sub>HZ1</sub>		25		30		35	ns	
CE2 to output in high impedance	t <sub>HZ2</sub>		25		30		35	ns	
/OE to output in high impedance	t <sub>OHZ</sub>		25		30		35	ns	
/LB, /UB to output in high impedance	t <sub>BHZ</sub>		25		30		35	ns	

- Notes 1. The output load is 1TTL + 30 pF.  
 2. The output load is 1TTL + 5 pF.

Read Cycle (3/3) (DD version)

Parameter	Symbol	μPD442012A -DD85X		μPD442012A -DD10X		μPD442012A -DD12X		Unit	Condition
		MIN.	MAX.	MIN.	MAX.	MIN.	MAX.		
Read cycle time	t <sub>RC</sub>	85		100		120		ns	
Address access time	t <sub>AA</sub>		85		100		120	ns	Note 1
/CE1 access time	t <sub>CO1</sub>		85		100		120	ns	
CE2 access time	t <sub>CO2</sub>		85		100		120	ns	
/OE to output valid	t <sub>OE</sub>		40		50		60	ns	
/LB, /UB to output valid	t <sub>BA</sub>		85		100		120	ns	
Output hold from address change	t <sub>OH</sub>	10		10		10		ns	
/CE1 to output in low impedance	t <sub>LZ1</sub>	10		10		10		ns	Note 2
CE2 to output in low impedance	t <sub>LZ2</sub>	10		10		10		ns	
/OE to output in low impedance	t <sub>OLZ</sub>	5		5		5		ns	
/LB, /UB to output in low impedance	t <sub>BLZ</sub>	10		10		10		ns	
/CE1 to output in high impedance	t <sub>HZ1</sub>		30		35		40	ns	
CE2 to output in high impedance	t <sub>HZ2</sub>		30		35		40	ns	
/OE to output in high impedance	t <sub>OHZ</sub>		30		35		40	ns	
/LB, /UB to output in high impedance	t <sub>BHZ</sub>		30		35		40	ns	

- Notes 1. The output load is 1TTL + 30 pF.  
 2. The output load is 1TTL + 5 pF.

Read Cycle Timing Chart

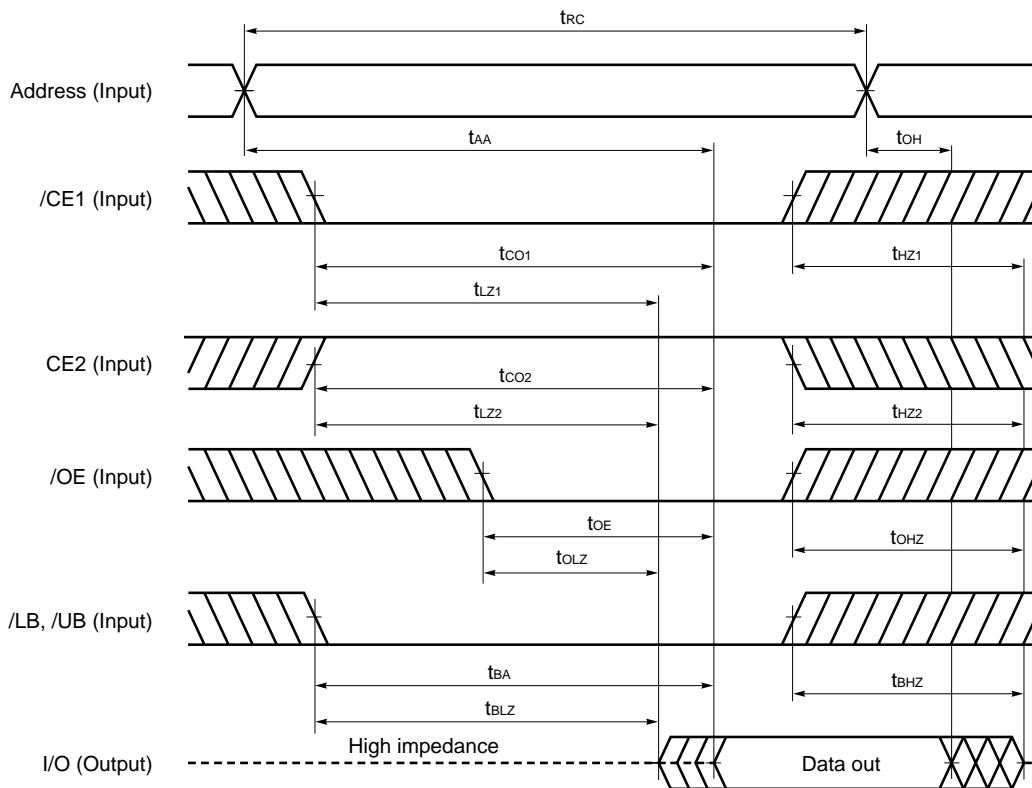

Remark In read cycle, /WE should be fixed to high level.

★ Write Cycle (1/3) (BB version)

Parameter	Symbol	μPD442012A-BB55X				μPD442012A		μPD442012A		Unit	Condition
		V <sub>CC</sub> ≥ 3.0 V				-BB70X		-BB85X			
		MIN.	MAX.	MIN.	MAX.	MIN.	MAX.	MIN.	MAX.		
Write cycle time	t <sub>WC</sub>	50		55		70		85		ns	
/CE1 to end of write	t <sub>CW1</sub>	45		50		55		70		ns	
CE2 to end of write	t <sub>CW2</sub>	45		50		55		70		ns	
/LB, /UB to end of write	t <sub>BW</sub>	45		50		55		70		ns	
Address valid to end of write	t <sub>AW</sub>	45		50		55		70		ns	
Address setup time	t <sub>AS</sub>	0		0		0		0		ns	
Write pulse width	t <sub>WP</sub>	40		45		50		55		ns	
Write recovery time	t <sub>WR</sub>	0		0		0		0		ns	
Data valid to end of write	t <sub>DW</sub>	25		25		30		35		ns	
Data hold time	t <sub>DH</sub>	0		0		0		0		ns	
/WE to output in high impedance	t <sub>WHZ</sub>		20		20		25		30	ns	<b>Note</b>
Output active from end of write	t <sub>OW</sub>	5		5		5		5		ns	

**Note** The output load is 1TTL + 5 pF.

Write Cycle (2/3) (BC version)

Parameter	Symbol	μPD442012A		μPD442012A		μPD442012A		Unit	Condition
		-BC70X		-BC85X		-BC10X			
		MIN.	MAX.	MIN.	MAX.	MIN.	MAX.		
Write cycle time	t <sub>WC</sub>	70		85		100		ns	
/CE1 to end of write	t <sub>CW1</sub>	55		70		80		ns	
CE2 to end of write	t <sub>CW2</sub>	55		70		80		ns	
/LB, /UB to end of write	t <sub>BW</sub>	55		70		80		ns	
Address valid to end of write	t <sub>AW</sub>	55		70		80		ns	
Address setup time	t <sub>AS</sub>	0		0		0		ns	
Write pulse width	t <sub>WP</sub>	50		55		60		ns	
Write recovery time	t <sub>WR</sub>	0		0		0		ns	
Data valid to end of write	t <sub>DW</sub>	30		35		40		ns	
Data hold time	t <sub>DH</sub>	0		0		0		ns	
/WE to output in high impedance	t <sub>WHZ</sub>		25		30		35	ns	<b>Note</b>
Output active from end of write	t <sub>OW</sub>	5		5		5		ns	

**Note** The output load is 1TTL + 5 pF.

Write Cycle (3/3) (DD version)

Parameter	Symbol	μPD442012A -DD85X		μPD442012A -DD10X		μPD442012A -DD12X		Unit	Condition
		MIN.	MAX.	MIN.	MAX.	MIN.	MAX.		
Write cycle time	t <sub>WC</sub>	85		100		120		ns	
/CE1 to end of write	t <sub>CW1</sub>	70		80		100		ns	
CE2 to end of write	t <sub>CW2</sub>	70		80		100		ns	
/LB, /UB to end of write	t <sub>BW</sub>	70		80		100		ns	
Address valid to end of write	t <sub>AW</sub>	70		80		100		ns	
Address setup time	t <sub>AS</sub>	0		0		0		ns	
Write pulse width	t <sub>WP</sub>	55		60		85		ns	
Write recovery time	t <sub>WR</sub>	0		0		0		ns	
Data valid to end of write	t <sub>DW</sub>	35		40		60		ns	
Data hold time	t <sub>DH</sub>	0		0		0		ns	
/WE to output in high impedance	t <sub>WHZ</sub>		30		35		40	ns	<b>Note</b>
Output active from end of write	t <sub>OW</sub>	5		5		5		ns	

**Note** The output load is 1TTL + 5 pF.

Write Cycle Timing Chart 1 (/WE Controlled)

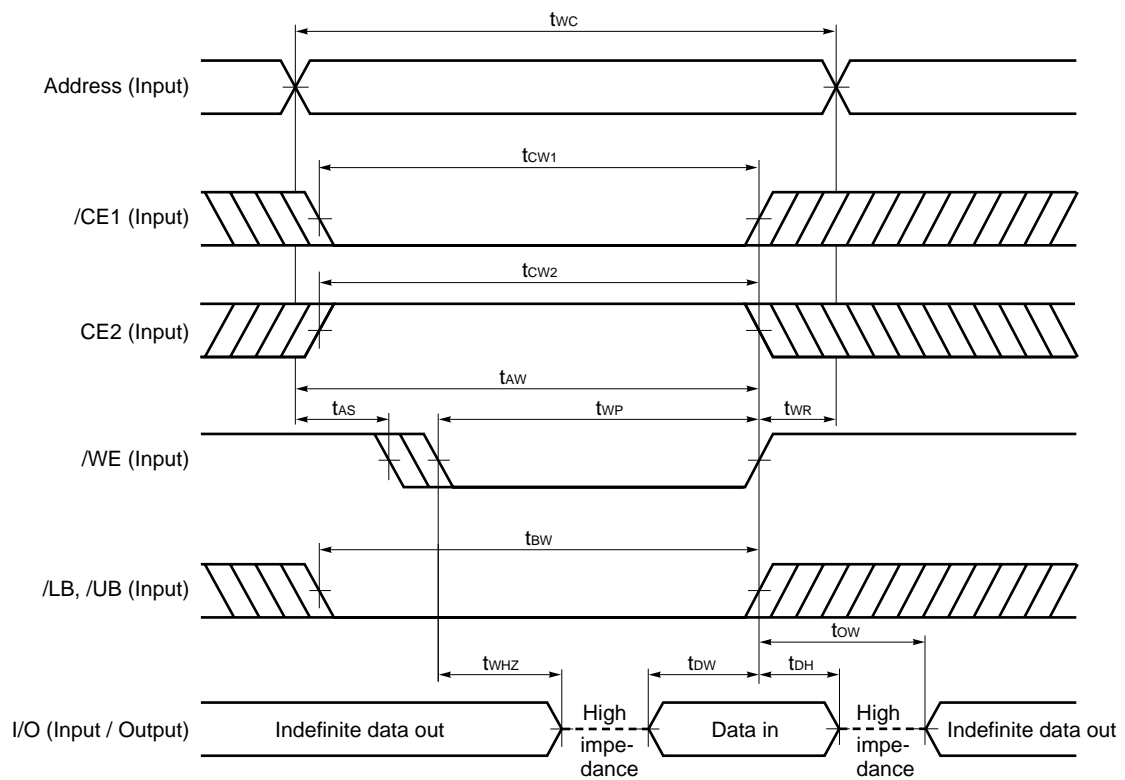

- Cautions**
1. During address transition, at least one of pins /CE1, CE2, /WE should be inactivated.
  2. Do not input data to the I/O pins while they are in the output state.

- Remarks**
1. Write operation is done during the overlap time of a low level /CE1, a low level /WE, a low level /LB (or low level /UB) and a high level CE2.
  2. If /CE1 changes to low level at the same time or after the change of /WE to low level, or if CE2 changes to high level at the same time or after the change of /WE to low level, the I/O pins will remain high impedance state.
  3. When /WE is at low level, the I/O pins are always high impedance. When /WE is at high level, read operation is executed. Therefore /OE should be at high level to make the I/O pins high impedance.

Write Cycle Timing Chart 2 (/CE1 Controlled)

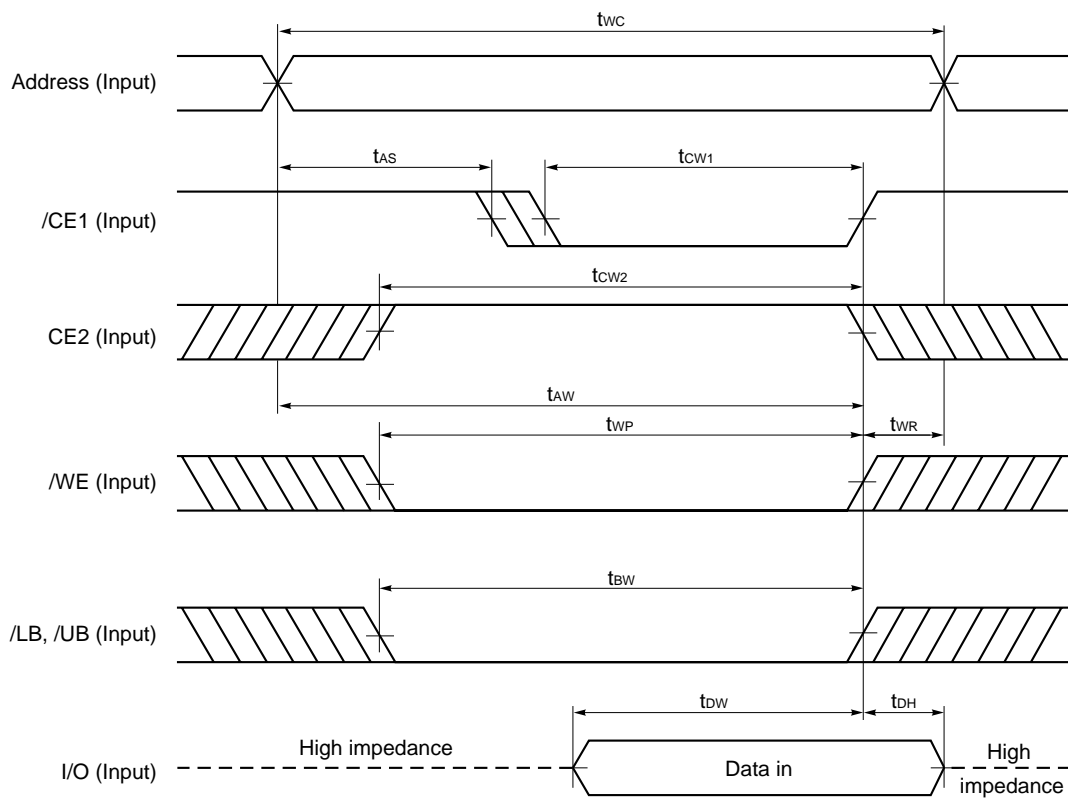

- Cautions**
1. During address transition, at least one of pins  $\overline{CE1}$ , CE2,  $\overline{WE}$  should be inactivated.
  2. Do not input data to the I/O pins while they are in the output state.

**Remark** Write operation is done during the overlap time of a low level  $\overline{CE1}$ , a low level  $\overline{WE}$ , a low level  $\overline{LB}$  (or low level  $\overline{UB}$ ) and a high level CE2.

Write Cycle Timing Chart 3 (CE2 Controlled)

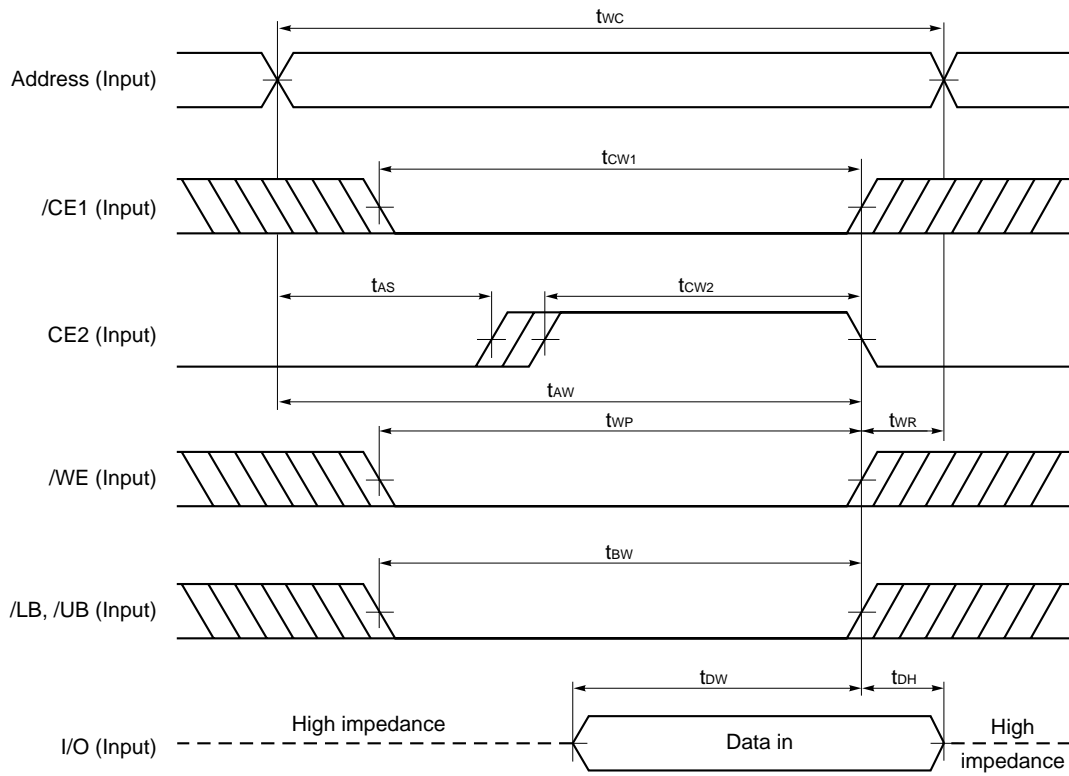

- Cautions**
1. During address transition, at least one of pins /CE1, CE2, /WE should be inactivated.
  2. Do not input data to the I/O pins while they are in the output state.

**Remark** Write operation is done during the overlap time of a low level /CE1, a low level /WE, a low level /LB (or low level /UB) and a high level CE2.



Write Cycle Timing Chart 4 (/LB, /UB Controlled)

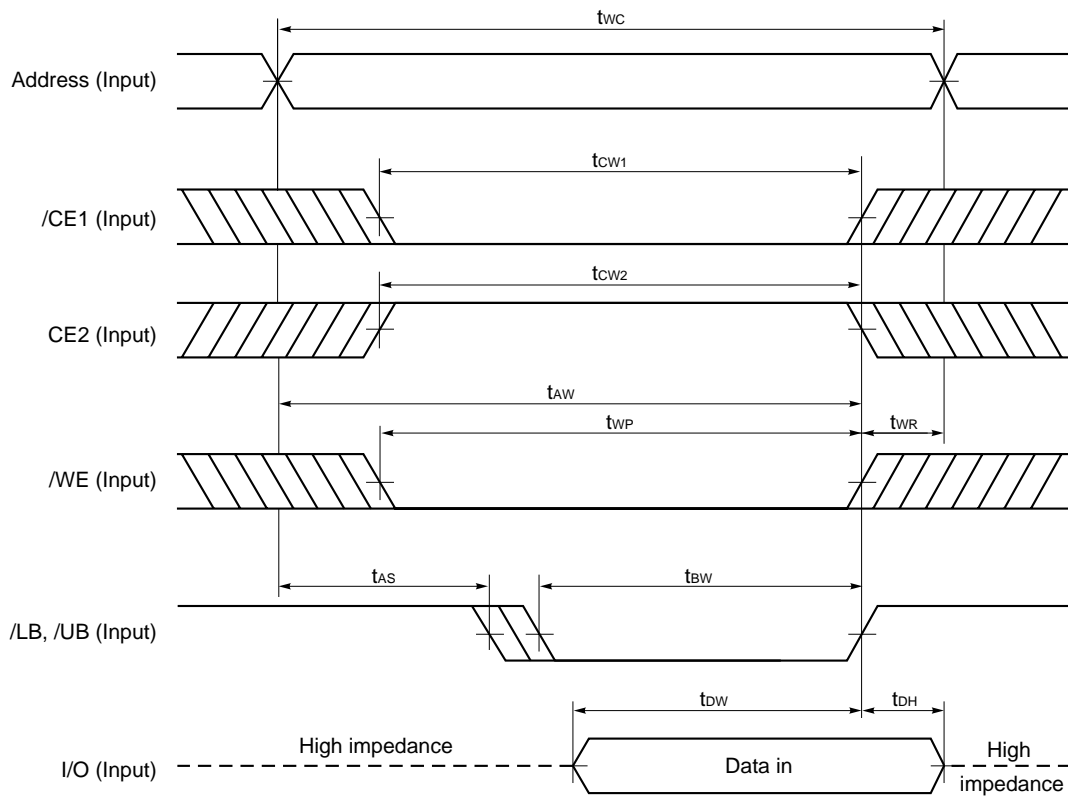

- Cautions**
1. During address transition, at least one of pins /CE1, CE2, /WE should be inactivated.
  2. Do not input data to the I/O pins while they are in the output state.

**Remark** Write operation is done during the overlap time of a low level /CE1, a low level /WE, a low level /LB (or low level /UB) and a high level CE2.

Low V<sub>CC</sub> Data Retention Characteristics (T<sub>A</sub> = -25 to +85 °C)

Parameter	Symbol	Test Condition	μPD442012A -BBxxX			μPD442012A -BCxxX			μPD442012A -DDxxX			Unit
			MIN.	TYP.	MAX.	MIN.	TYP.	MAX.	MIN.	TYP.	MAX.	
Data retention supply voltage	V <sub>CCDR1</sub>	/CE1 ≥ V <sub>CC</sub> - 0.2 V, CE2 ≥ V <sub>CC</sub> - 0.2 V	1.0		3.6	1.0		3.6	1.0		2.2	V
	V <sub>CCDR2</sub>	CE2 ≤ 0.2 V	1.0		3.6	1.0		3.6	1.0		2.2	
	V <sub>CCDR3</sub>	/LB = /UB ≥ V <sub>CC</sub> - 0.2 V, /CE1 ≤ 0.2 V, CE2 ≥ V <sub>CC</sub> - 0.2 V	1.0		3.6	1.0		3.6	1.0		2.2	
★ Data retention supply current	I <sub>CCDR1</sub>	V <sub>CC</sub> = 1.2 V, /CE1 ≥ V <sub>CC</sub> - 0.2 V, CE2 ≥ V <sub>CC</sub> - 0.2 V		0.15	2		0.15	2		0.15	2	μA
	I <sub>CCDR2</sub>	V <sub>CC</sub> = 1.2 V, CE2 ≤ 0.2 V		0.15	2		0.15	2		0.15	2	
	I <sub>CCDR3</sub>	V <sub>CC</sub> = 1.2 V, /LB = /UB ≥ V <sub>CC</sub> - 0.2 V, /CE1 ≤ 0.2 V, CE2 ≥ V <sub>CC</sub> - 0.2 V		0.15	2		0.15	2		0.15	2	
Chip deselection to data retention mode	t <sub>CDR</sub>		0			0			0			ns
Operation recovery time	t <sub>R</sub>		t <sub>RC</sub> <sup>Note</sup>			t <sub>RC</sub> <sup>Note</sup>			t <sub>RC</sub> <sup>Note</sup>			ns

**Note** t<sub>RC</sub> : Read cycle time

**Data Retention Timing Chart**

**(1) /CE1 Controlled**

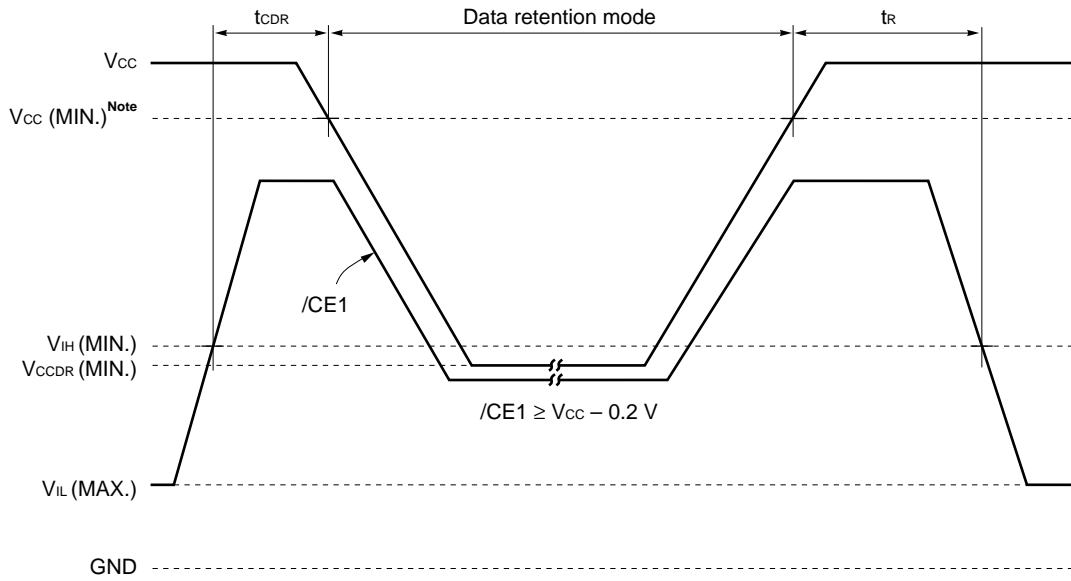

**Note** BB version : 2.7 V, BC version : 2.2 V, DD version : 1.8 V

**Remark** On the data retention mode by controlling  $\overline{CE1}$ , the input level of CE2 must be  $\geq V_{CC} - 0.2 V$  or  $\leq 0.2 V$ . The other pins (Address, I/O,  $\overline{WE}$ ,  $\overline{OE}$ ,  $\overline{LB}$ ,  $\overline{UB}$ ) can be in high impedance state.

**(2) CE2 Controlled**

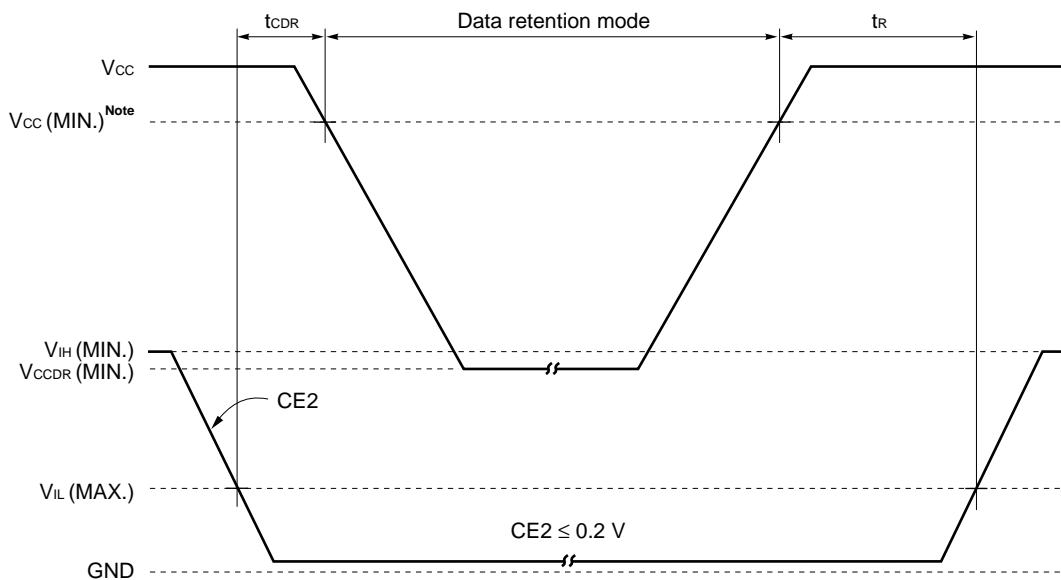

**Note** BB version : 2.7 V, BC version : 2.2 V, DD version : 1.8 V

**Remark** On the data retention mode by controlling CE2, the other pins ( $\overline{CE1}$ , Address, I/O,  $\overline{WE}$ ,  $\overline{OE}$ ,  $\overline{LB}$ ,  $\overline{UB}$ ) can be in high impedance state.

(3) /LB, /UB Controlled

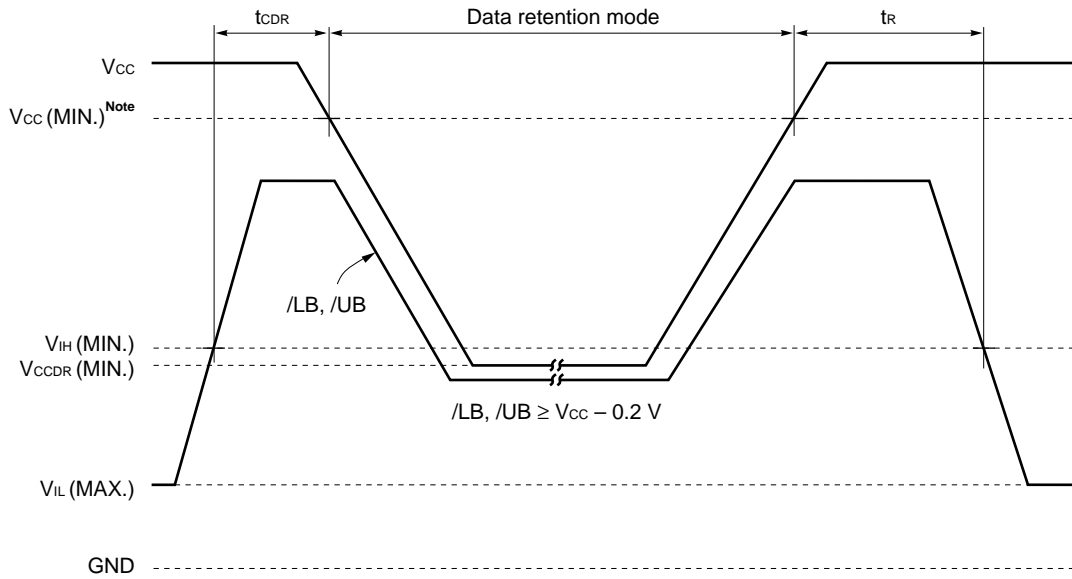

**Note** BB version : 2.7 V, BC version : 2.2 V, DD version : 1.8 V

**Remark** On the data retention mode by controlling /LB and /UB, the input level of /CE1 and CE2 must be  $\geq V_{CC} - 0.2 V$  or  $\leq 0.2 V$ . The other pins (Address, I/O, /WE, /OE) can be in high impedance state.

Package Drawing

48-PIN PLASTIC TSOP(I) (12x18)

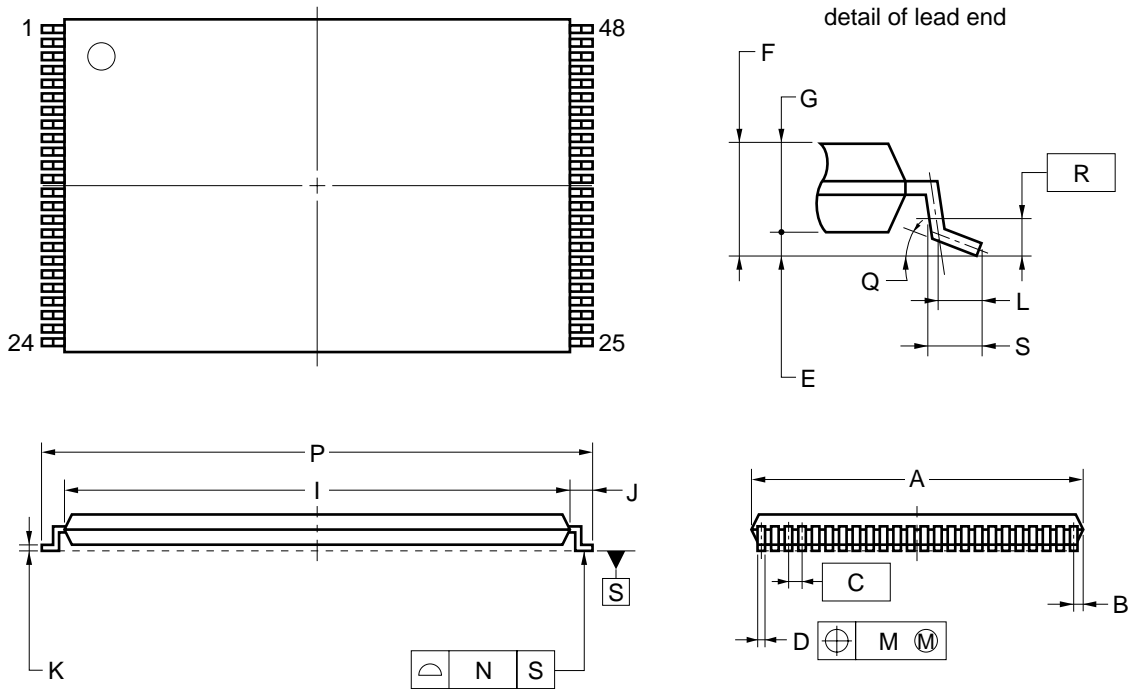

NOTES

1. Each lead centerline is located within 0.10 mm of its true position (T.P.) at maximum material condition.
2. "A" excludes mold flash. (Includes mold flash : 12.4 mm MAX.)

ITEM	MILLIMETERS
A	12.0±0.1
B	0.45 MAX.
C	0.5 (T.P.)
D	0.22±0.05
E	0.1±0.05
F	1.2 MAX.
G	1.0±0.05
I	16.4±0.1
J	0.8±0.2
K	0.145±0.05
L	0.5
M	0.10
N	0.10
P	18.0±0.2
Q	3° <sup>+5°</sup> -3°
R	0.25
S	0.60±0.15

S48GY-50-MJH1-1

**Recommended Soldering Conditions**

Please consult with our sales offices for soldering conditions of the  $\mu$ PD442012A-X.

**Types of Surface Mount Device**

$\mu$ PD442012AGY-BBxxX-MJH : 48-pin PLASTIC TSOP (I) (12×18) (Normal bent)

$\mu$ PD442012AGY-BCxxX-MJH : 48-pin PLASTIC TSOP (I) (12×18) (Normal bent)

$\mu$ PD442012AGY-DDxxX-MJH : 48-pin PLASTIC TSOP (I) (12×18) (Normal bent)

**NOTES FOR CMOS DEVICES****① PRECAUTION AGAINST ESD FOR SEMICONDUCTORS**

Note:

Strong electric field, when exposed to a MOS device, can cause destruction of the gate oxide and ultimately degrade the device operation. Steps must be taken to stop generation of static electricity as much as possible, and quickly dissipate it once, when it has occurred. Environmental control must be adequate. When it is dry, humidifier should be used. It is recommended to avoid using insulators that easily build static electricity. Semiconductor devices must be stored and transported in an anti-static container, static shielding bag or conductive material. All test and measurement tools including work bench and floor should be grounded. The operator should be grounded using wrist strap. Semiconductor devices must not be touched with bare hands. Similar precautions need to be taken for PW boards with semiconductor devices on it.

**② HANDLING OF UNUSED INPUT PINS FOR CMOS**

Note:

No connection for CMOS device inputs can be cause of malfunction. If no connection is provided to the input pins, it is possible that an internal input level may be generated due to noise, etc., hence causing malfunction. CMOS devices behave differently than Bipolar or NMOS devices. Input levels of CMOS devices must be fixed high or low by using a pull-up or pull-down circuitry. Each unused pin should be connected to  $V_{DD}$  or GND with a resistor, if it is considered to have a possibility of being an output pin. All handling related to the unused pins must be judged device by device and related specifications governing the devices.

**③ STATUS BEFORE INITIALIZATION OF MOS DEVICES**

Note:

Power-on does not necessarily define initial status of MOS device. Production process of MOS does not define the initial operation status of the device. Immediately after the power source is turned ON, the devices with reset function have not yet been initialized. Hence, power-on does not guarantee out-pin levels, I/O settings or contents of registers. Device is not initialized until the reset signal is received. Reset operation must be executed immediately after power-on for devices having reset function.

- **The information in this document is current as of July, 2001. The information is subject to change without notice. For actual design-in, refer to the latest publications of NEC's data sheets or data books, etc., for the most up-to-date specifications of NEC semiconductor products. Not all products and/or types are available in every country. Please check with an NEC sales representative for availability and additional information.**
  - No part of this document may be copied or reproduced in any form or by any means without prior written consent of NEC. NEC assumes no responsibility for any errors that may appear in this document.
  - NEC does not assume any liability for infringement of patents, copyrights or other intellectual property rights of third parties by or arising from the use of NEC semiconductor products listed in this document or any other liability arising from the use of such products. No license, express, implied or otherwise, is granted under any patents, copyrights or other intellectual property rights of NEC or others.
  - Descriptions of circuits, software and other related information in this document are provided for illustrative purposes in semiconductor product operation and application examples. The incorporation of these circuits, software and information in the design of customer's equipment shall be done under the full responsibility of customer. NEC assumes no responsibility for any losses incurred by customers or third parties arising from the use of these circuits, software and information.
  - While NEC endeavours to enhance the quality, reliability and safety of NEC semiconductor products, customers agree and acknowledge that the possibility of defects thereof cannot be eliminated entirely. To minimize risks of damage to property or injury (including death) to persons arising from defects in NEC semiconductor products, customers must incorporate sufficient safety measures in their design, such as redundancy, fire-containment, and anti-failure features.
  - NEC semiconductor products are classified into the following three quality grades:  
"Standard", "Special" and "Specific". The "Specific" quality grade applies only to semiconductor products developed based on a customer-designated "quality assurance program" for a specific application. The recommended applications of a semiconductor product depend on its quality grade, as indicated below. Customers must check the quality grade of each semiconductor product before using it in a particular application.  
"Standard": Computers, office equipment, communications equipment, test and measurement equipment, audio and visual equipment, home electronic appliances, machine tools, personal electronic equipment and industrial robots  
"Special": Transportation equipment (automobiles, trains, ships, etc.), traffic control systems, anti-disaster systems, anti-crime systems, safety equipment and medical equipment (not specifically designed for life support)  
"Specific": Aircraft, aerospace equipment, submersible repeaters, nuclear reactor control systems, life support systems and medical equipment for life support, etc.
- The quality grade of NEC semiconductor products is "Standard" unless otherwise expressly specified in NEC's data sheets or data books, etc. If customers wish to use NEC semiconductor products in applications not intended by NEC, they must contact an NEC sales representative in advance to determine NEC's willingness to support a given application.
- (Note)
- (1) "NEC" as used in this statement means NEC Corporation and also includes its majority-owned subsidiaries.  
(2) "NEC semiconductor products" means any semiconductor product developed or manufactured by or for NEC (as defined above).



This datasheet has been download from:

[www.datasheetcatalog.com](http://www.datasheetcatalog.com)

Datasheets for electronics components.