

# PQ30RV1/PQ30RV11/PQ30RV2/PQ30RV21

Variable Output Low Power-Loss Voltage Regulators

## ■ Features

- Compact resin full-mold package
- Low power-loss (Dropout voltage : MAX.0.5V)
- Variable output voltage (setting range : 1.5 to 30V)
- Built-in output ON/OFF control function

## ■ Applications

- Power supply for print concentration control of electronic typewriters with display
- Series power supply for motor drives
- Series power supply for VCRs and TVs

## ■ Model Line-ups

Output voltage	1A output	2A output
Reference voltage precision : $\pm 4\%$	PQ30RV1	PQ30RV2
Reference voltage precision : $\pm 2\%$	PQ30RV11	PQ30RV21

## ■ Equivalent Circuit Diagram

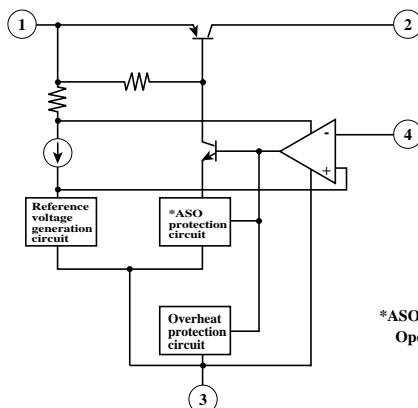

\*ASO:Area of Safety Operation

## ■ Outline Dimensions

(Unit : mm)

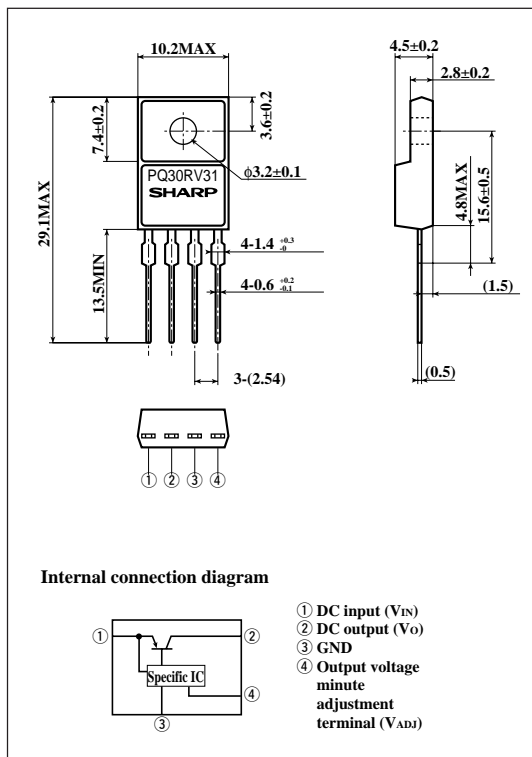

· Please refer to the chapter "Handling Precautions".

**SHARP**

" In the absence of confirmation by device specification sheets, SHARP takes no responsibility for any defects that may occur in equipment using any SHARP devices shown in catalogs, data books, etc. Contact SHARP in order to obtain the latest version of the device specification sheets before using any SHARP's device. "

■ Absolute Maximum Ratings

(T<sub>a</sub>=25°C)

Parameter		Symbol	Rating	Unit
*1 Input voltage		V <sub>IN</sub>	35	V
*1 Output voltage adjustment voltage		V <sub>ADJ</sub>	7	V
Output current	PQ30RV1/PQ30RV11	I <sub>o</sub>	1	A
	PQ30RV2/PQ30RV21		2	
Power dissipation (No heat sink)		P <sub>D1</sub>	1.5	W
Power dissipation (With infinite heat sink)	PQ30RV1/PQ30RV11	P <sub>D2</sub>	15	W
	PQ30RV2/PQ30RV21		18	
*2 Junction temperature		T <sub>j</sub>	150	°C
Operating temperature		T <sub>opr</sub>	-20to+80	°C
Storage temperature		T <sub>stg</sub>	-40to+150	°C
Soldering temperature		T <sub>sol</sub>	260 (For 10s)	°C

\*1 All are open except GND and applicable terminals.

\*2 Overheat protection may operate at T<sub>j</sub>>=125°C.

■ Electrical Characteristics

Unless otherwise specified, condition shall be

V<sub>IN</sub>=15V, V<sub>o</sub>=10V, I<sub>o</sub>=0.5A, R<sub>i</sub>=390Ω (PQ30RV1/PQ30RV11)

V<sub>IN</sub>=15V, V<sub>o</sub>=10V, I<sub>o</sub>=1.0A, R<sub>i</sub>=390Ω (PQ30RV2/PQ30RV21)

(T<sub>a</sub>=25°C)

Parameter		Symbol	Conditions	MIN.	TYP.	MAX.	Unit	
Input voltage		V <sub>IN</sub>	-	4.5	-	35	V	
Output voltage	PQ30RV1/PQ30RV2	V <sub>o</sub>	R <sub>2</sub> =94Ω to 8.5kΩ	1.5	-	30	V	
	PQ30RV11/PQ30RV21		R <sub>2</sub> =84Ω to 8.7kΩ					
Load regulation	PQ30RV1/PQ30RV11	R <sub>regL</sub>	I <sub>o</sub> =5mA to 1A	-	0.3	1.0	%	
	PQ30RV2/PQ30RV21		I <sub>o</sub> =5mA to 2A	-	0.5	1.0		
Line regulation		R <sub>regI</sub>	V <sub>IN</sub> =11 to 28V	-	0.5	2.5	%	
Ripple rejection	RR		C <sub>ref</sub> =0	Fefer to Fig. 2	45	55	-	dB
			C <sub>ref</sub> =3.3μF		55	65	-	
Reference voltage	PQ30RV1/PQ30RV2	V <sub>ref</sub>	-	1.20	1.25	1.30	V	
	PQ30RV11/PQ30RV21			1.225	1.25	1.275		
Temperature coefficient of reference voltage		T <sub>c</sub> V <sub>ref</sub>	T <sub>j</sub> =0 to 125°C	-	±1.0	-	%	
Dropout voltage	PQ30RV1/PQ30RV11	V <sub>i-o</sub>	*3, I <sub>o</sub> =0.5A	-	-	0.5	V	
	PQ30RV2/PQ30RV21		*3, I <sub>o</sub> =2A					
Quiescent current		I <sub>q</sub>	I <sub>o</sub> =0	-	-	7	mA	

\*3 Input voltage shall be the value when output voltage is 95% in comparison with the initial value.

Fig.1 Test Circuit

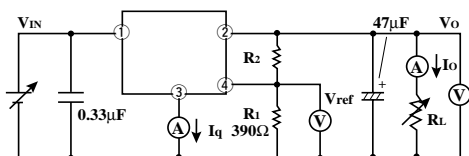

$$V_o = V_{ref} \times \left( 1 + \frac{R_2}{R_1} \right) \approx 1.25 \times \left( 1 + \frac{R_2}{R_1} \right)$$

[R<sub>1</sub>=390Ω, V<sub>ref</sub>≈1.25V]

Fig.2 Test Circuit of Ripple Rejection

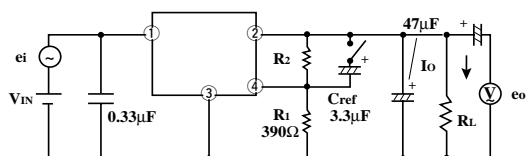

I<sub>o</sub>=0.5A  
f=120Hz (sine wave)  
e<sub>i</sub>=0.5V<sub>rms</sub>  
RR=20 log (e<sub>i</sub>/e<sub>o</sub>)

Fig.3 Power Dissipation vs. Ambient Temperature (PQ30RV1/PQ30RV11)

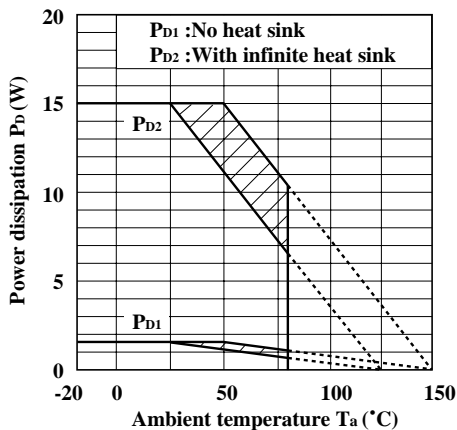

Note) Oblique line portion:Overheat protection may operate in this area.

Fig.4 Power Dissipation vs. Ambient Temperature (PQ30RV2/PQ30RV21)

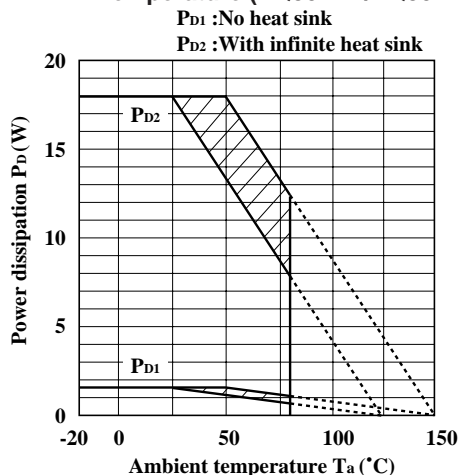

Note) Oblique line portion:Overheat protection may operate in this area.

Fig.5 Overcurrent Protection Characteristics (PQ30RV1/PQ30RV11)

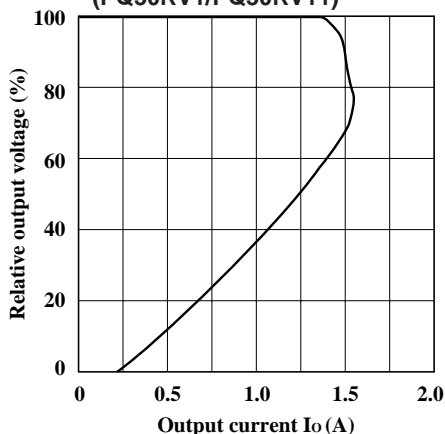

Fig.6 Overcurrent Protection Characteristics (PQ30RV2/PQ30RV21)

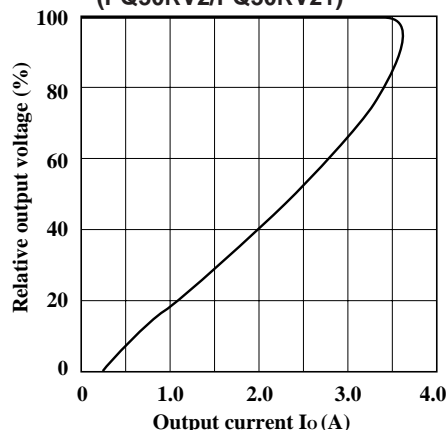

Fig.7 Output Voltage Adjustment Characteristics

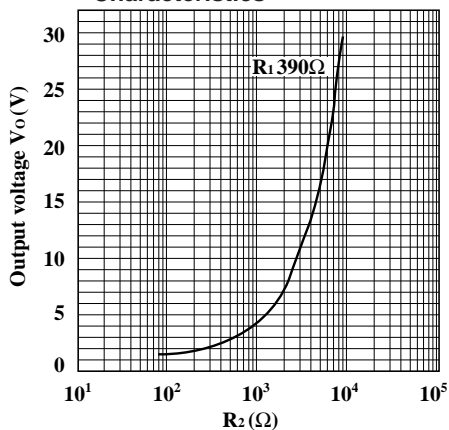

Fig.8 Reference Voltage Deviation vs. Junction Temperature

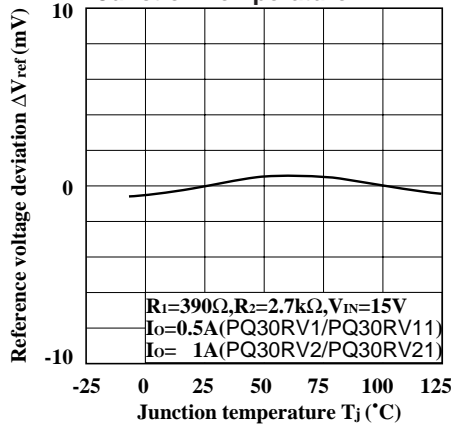

Fig.9 Output Voltage vs. Input Voltage (PQ30RV1/PQ30RV11)

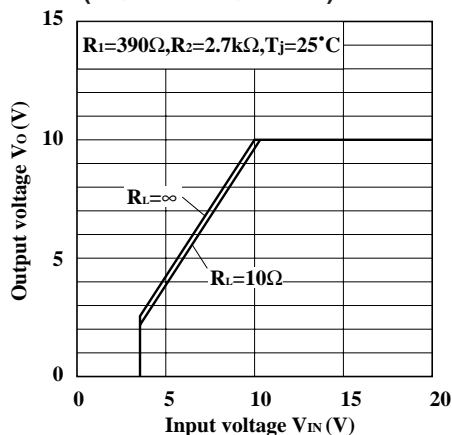

Fig.10 Output Voltage vs. Input Voltage (PQ30RV2/PQ30RV21)

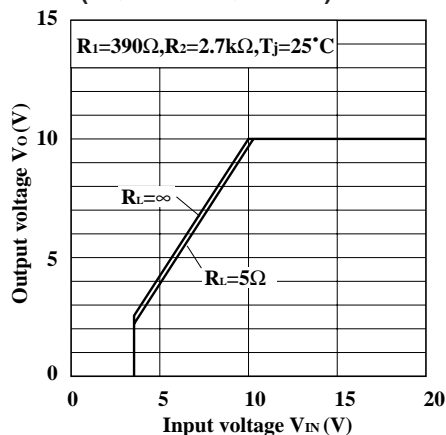

Fig.11 Dropout Voltage vs. Junction Temperature (PQ30RV1/PQ30RV11)

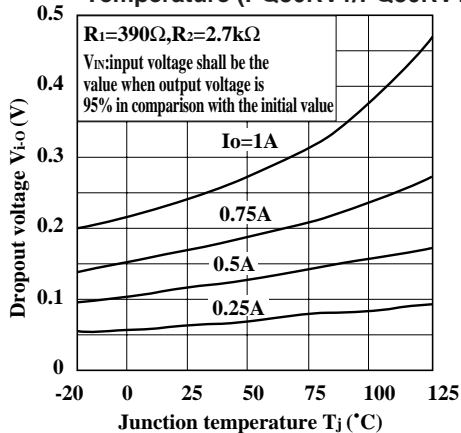

Fig.12 Dropout Voltage vs. Junction Temperature (PQ30RV2/PQ30RV21)

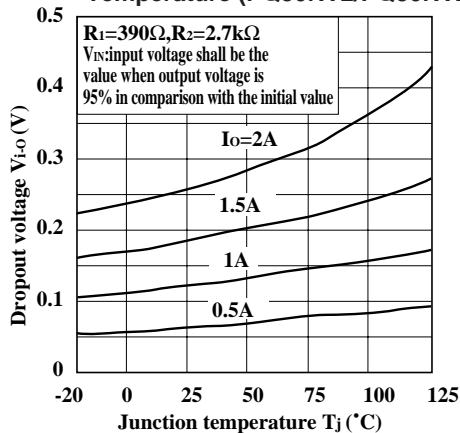

Fig.13 Quiescent Current vs. Junction Temperature

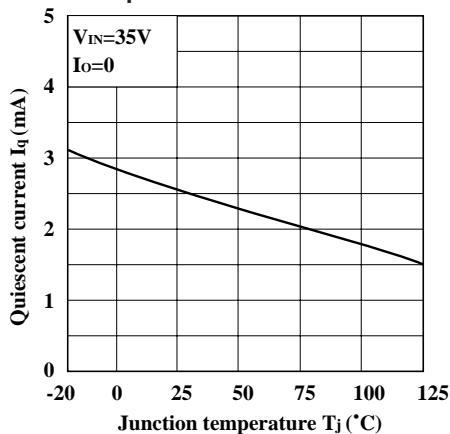

Fig.14 Ripple Rejection vs. Input Ripple Frequency (PQ30RV1/PQ30RV11)

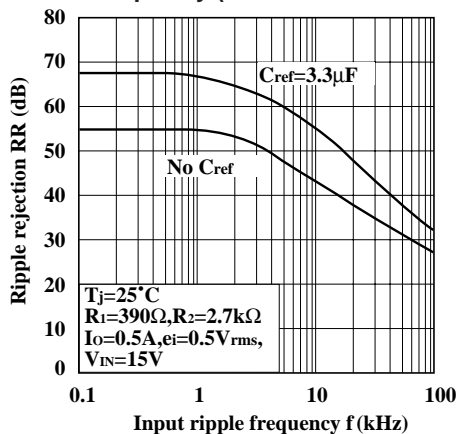

Fig.15 Ripple Rejection vs. Input Ripple Frequency (PQ30RV2/PQ30RV21)

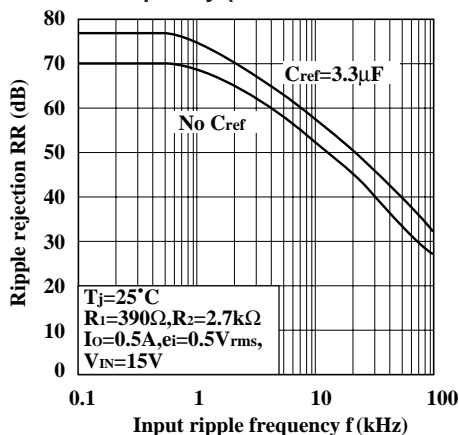

Fig.16 Ripple Rejection vs. Output Current (PQ30RV1/PQ30RV11)

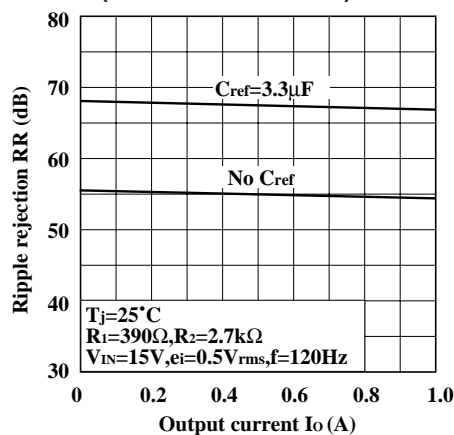

Fig.17 Ripple Rejection vs. Output Current (PQ30RV2/PQ30RV21)

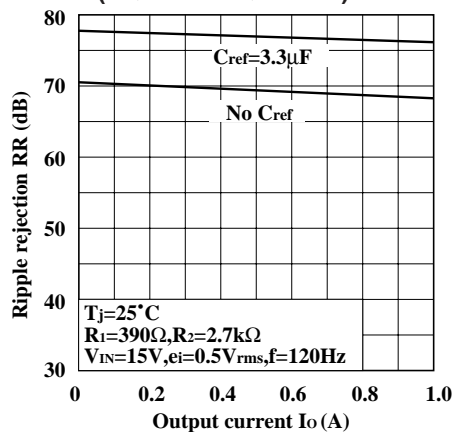

Fig.18 Output Peak Current vs. Dropout Voltage (PQ30RV1/PQ30RV11)

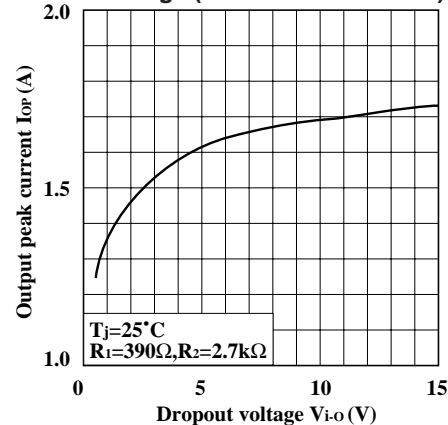

Fig.19 Output Peak Current vs. Dropout Voltage (PQ30RV2/PQ30RV21)

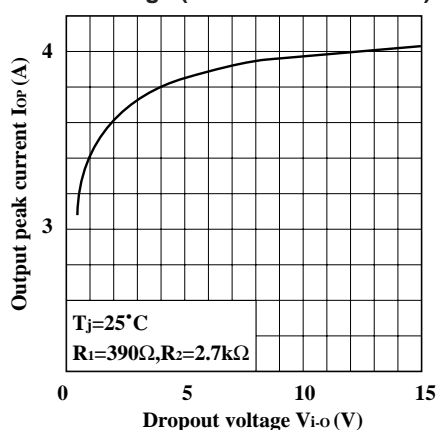

Fig.20 Output Peak Current vs. Junction Temperature (PQ30RV1/PQ30RV11)

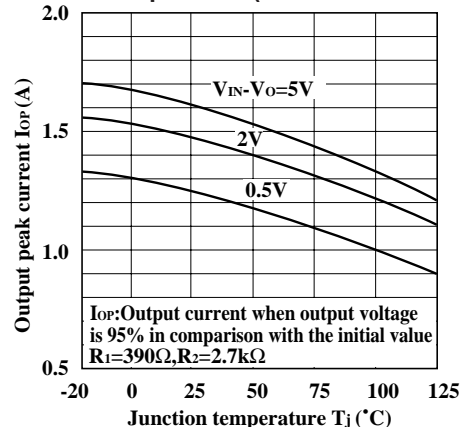
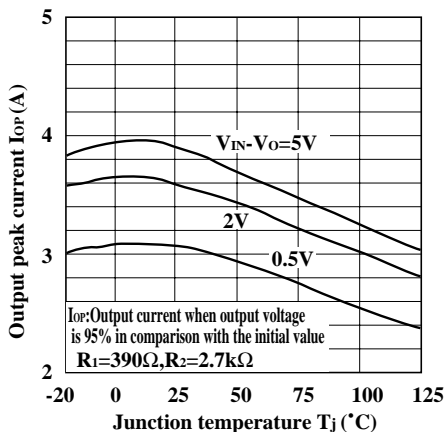
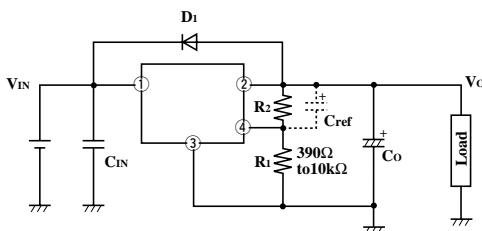

Fig.21 Output Peak Current vs. Junction Temperature (PQ30RV2/PQ30RV21)



■ Standard Connection



$D_1$  : This device is necessary to protect the element from damage when reverse voltage may be applied to the regulator in case of input short-circuiting.

$C_{ref}$  : This device is necessary when it is required to enhance the ripple rejection or to delay the output start-up time(\*1).

(\*1)Otherwise, it is not necessary.

(Care must be taken since  $C_{ref}$  may raise the gain, facilitating oscillation.)

(\*1)The output start-up time is proportional to  $C_{ref} \times R_2$ .

$C_{IN}, C_O$  : Be sure to mount the devices  $C_{IN}$  and  $C_O$  as close to the device terminal as possible so as to prevent oscillation.

The standard specification of  $C_{IN}$  and  $C_O$  is  $0.33\mu F$  and  $47\mu F$ , respectively. However, adjust them as necessary after checking.

$R_1, R_2$  : These devices are necessary to set the output voltage. The output voltage  $V_O$  is given by the following formula:

$$V_O = V_{ref} \times (1 + R_2/R_1)$$

( $V_{ref}$  is 1.25V TYP)

The standard value of  $R_1$  is  $390\Omega$ . But value up to  $10k\Omega$  does not cause any trouble.

■ ON/OFF Operation

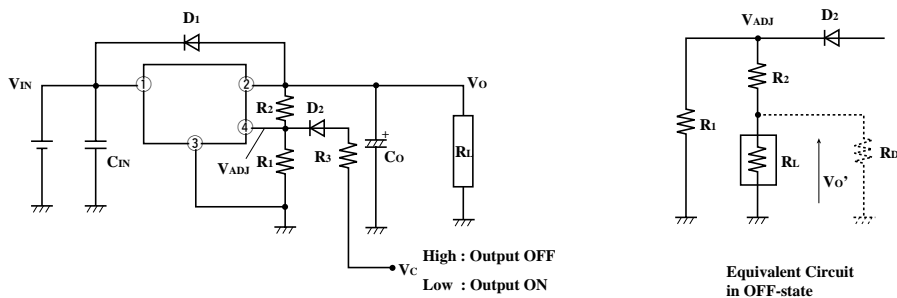

- ON/OFF operation is available by mounting externally D2 and R3.
- When V<sub>ADJ</sub> is forcibly raised above V<sub>ref</sub> (1.25V TYP) by applying the external signal, the output is turned off (pass transistor of regulator is turned off). When the output is OFF, V<sub>ADJ</sub> must be higher than V<sub>ref</sub> MAX., and at the same time must be lower than maximum rating 7V.  
In OFF-state, the load current flows to R<sub>L</sub> from V<sub>ADJ</sub> through R<sub>2</sub>. Therefore the value of R<sub>2</sub> must be as high as possible.
- $V_o' = V_{ADJ} \times R_L / (R_L + R_2)$   
occurs at the load. OFF-state equivalent circuit R<sub>1</sub> up to 10Ω is allowed. Select as high value of R<sub>L</sub> and R<sub>2</sub> as possible in this range. In some case, as output voltage is getting lower (V<sub>o</sub> < 1V), impedance of load resistance rises. In such condition, it is sometime impossible to obtain the minimum value of V<sub>o'</sub>. So add the dummy resistance indicated by R<sub>D</sub> in the figure to the circuit parallel to the load.

■ An Example of ON/OFF Circuit Using the 1-chip Microcomputer Output Port (PQ30RV1)

<p>&lt;Specification&gt;                  Output port of microcomputer                  V<sub>OH</sub>(max) = 0.5 V                  V<sub>OH</sub>(min) = 2.4 V (I<sub>OH</sub> = 0.2mA)                  MAX. rating of I<sub>OH</sub> = 0.5mA                  Output should be set as follows.                  15.6V R<sub>L</sub> = 52Ω (I<sub>o</sub> = 0.3A)</p>
--

From  $V_o = 1.25V (1 + R_2/R_1)$  we get  $V_o = 15.6V$ .

$R_2/R_1 = 11.48$

Assuming that V<sub>F</sub>(max) = 0.8V for D<sub>2</sub> in case of V<sub>OH</sub>(min) = 2.4V, we get  $V_{ADJ} = V_{OH}(min) - V_F(max) = 2.4V - 0.8V = 1.6V$ . From V<sub>ref</sub>(max) = 1.3V we get R<sub>3</sub> = 0Ω

If R<sub>1</sub> = 10kΩ, we get  $R_2 = 11.48 \times R_1 = 114.8k\Omega$  and I<sub>OH</sub> as follows, ignoring R<sub>L</sub> (52Ω) :

$I_{OH} = 1.6V \times (R_1 + R_2) / R_1 \times R_2$   
 $= 1.6V \times (10k\Omega + 114.8k\Omega) / 10k\Omega \times 114.8k\Omega = 0.17mA$

Hence, I<sub>OH</sub> < 0.2mA. Therefore V<sub>OH</sub>(min) is ensured.

Next, assuming that V<sub>F</sub>(min) = 0.5V for D<sub>2</sub> in case of V<sub>OH</sub>(max), we get:

$I_{OH} = (5V - 0.5V) (R_1 + R_2) / R_1 \times R_2 = 0.49mA$  which is less than the rating.

Figure 1 shows the V<sub>o</sub>-V<sub>c</sub> characteristics when R<sub>1</sub> = 10kΩ, R<sub>2</sub> = 115kΩ, R<sub>3</sub> = 0Ω, V<sub>IN</sub> = 17V, R<sub>L</sub> = 52Ω, and D<sub>1</sub> = 1S2076A (Hitachi).

Output Voltage vs. Control Voltage (PQ30RV1)

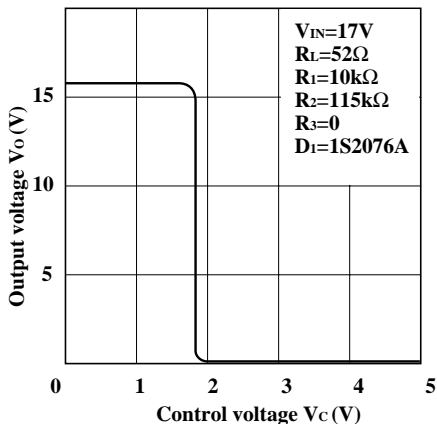

Model Line-ups for Lead Forming Type

Output voltage	5V output	2A output
Output voltage precision: $\pm 2.5\%$	PQ30RV1B	PQ30RV2B

Outline Dimensions (PQ30RV1B/PQ30RV2B)

(Unit : mm)

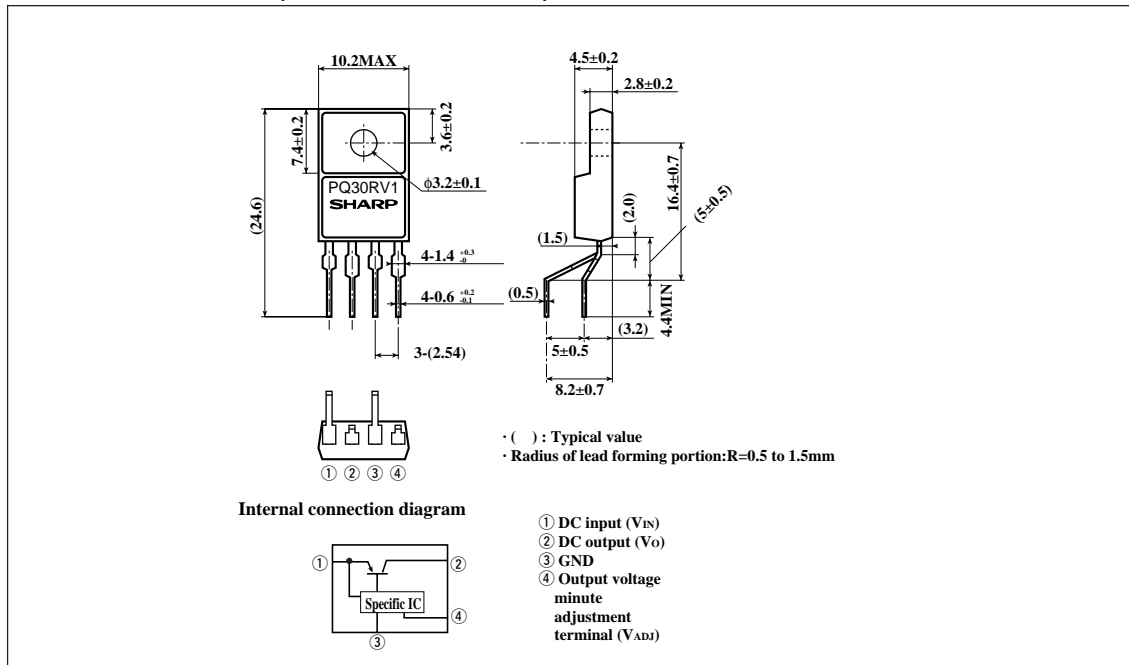

Note) The value of absolute maximum ratings and electrical characteristics is same as ones of PQ30RV1/2 series.